

Cassette-Corder

Mode d'emploi

Manual de instrucciones

Manual de instruções (lada inverso)

Istruzioni per l'uso (facciata opposta)

TCM-465V/459V

Sony Corporation ©1998 Printed in China



TCM-465V/459V

Sony Corporation ©1998 Printed in China

A propos de ce mode d'emploi

Les instructions contenues dans le présent mode d'emploi concernent les modèles TCM-465V et TCM-459V. Avant d'en entamer la lecture, vérifiez la désignation de votre modèle. C'est le modèle TCM-459V qui est représenté dans les illustrations. Toute différence de fonctionnement est clairement indiquée dans le texte, par exemple: "TCM-459V uniquement".

Acerca de este manual

Las instrucciones de este manual son para los modelos TCM-465V y TCM-459V. Antes de iniciar la lectura, compruebe el número de su modelo. El TCM-459V es el modelo empleado en las ilustraciones. Las diferencias de funcionamiento se indican claramente en el texto, por ejemplo, "solo para TCM-459V".

Este manual

As instruções deste manual dizem respeito aos modelos TCM-465V e TCM-459V. Antes de começar a ler, verifique o número do seu modelo. Nas ilustrações foi utilizado o modelo TCM-459V. Todas as diferenças de funcionamento estão claramente indicadas no texto, por exemplo, "só no modelo TCM-459V".

Informazioni sul manuale

Le istruzioni contenute in questo manuale si riferiscono ai modelli TCM-465V e TCM-459V. Prima di procedere nella lettura, controllare il numero del modello acquistato. Il modello TCM-459V viene utilizzato per scopi illustrativi. Le differenze nel funzionamento sono indicate in modo chiaro nel testo, ad esempio, "solo per il modello TCM-459V".

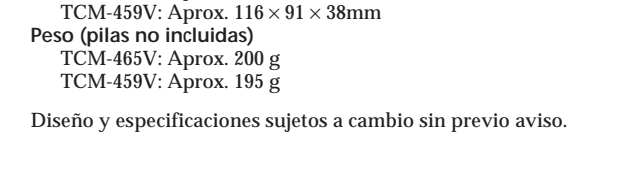
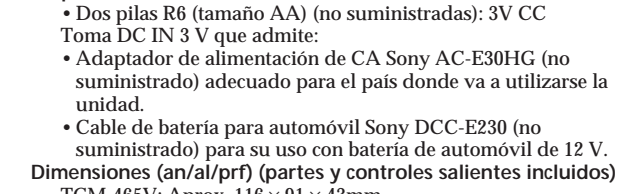
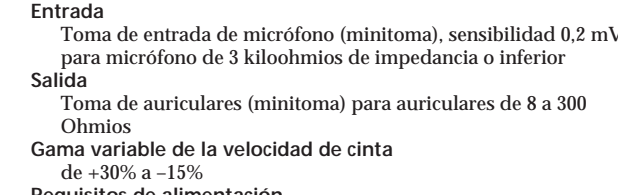
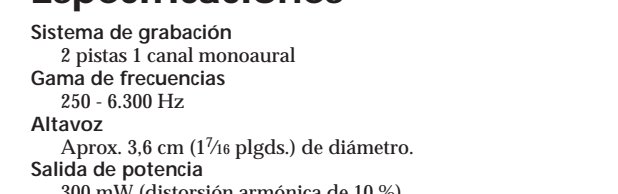
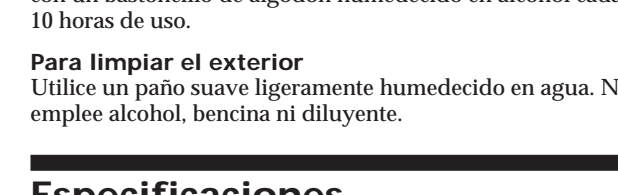
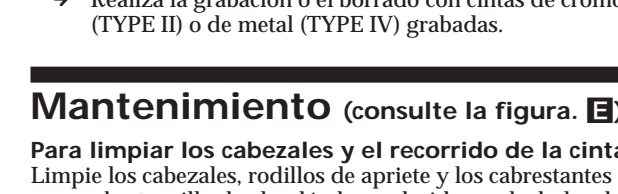
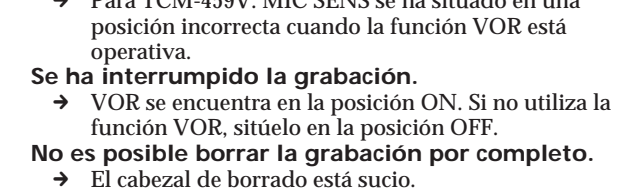
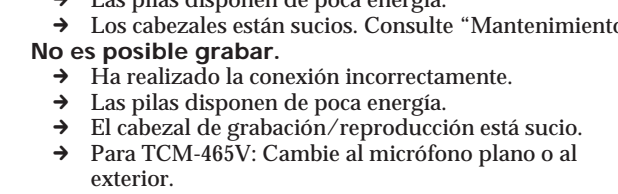
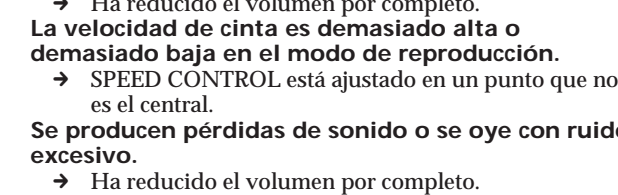
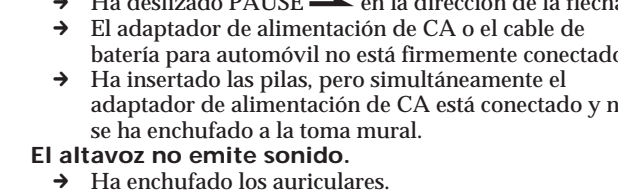
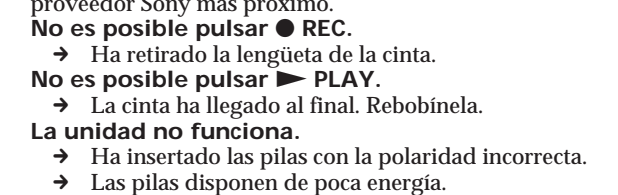
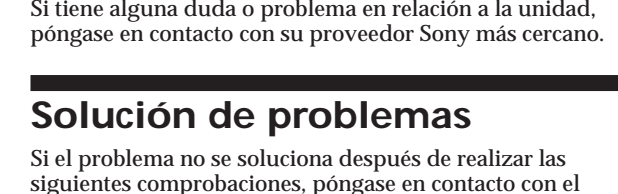
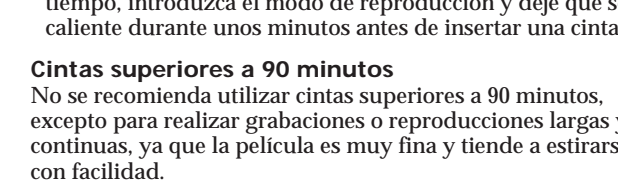
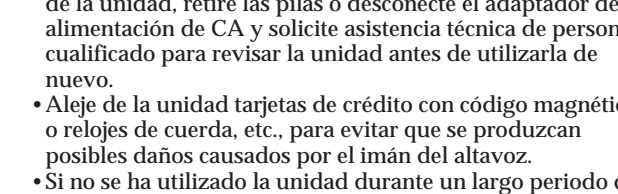
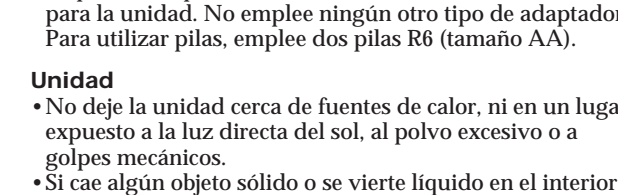
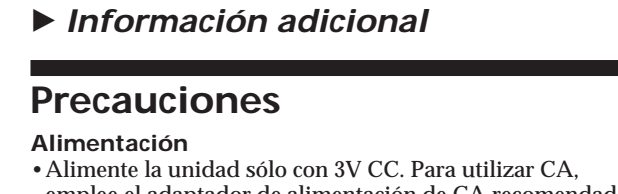
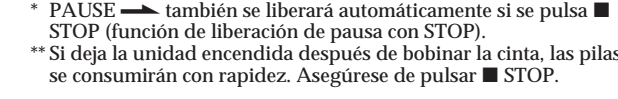
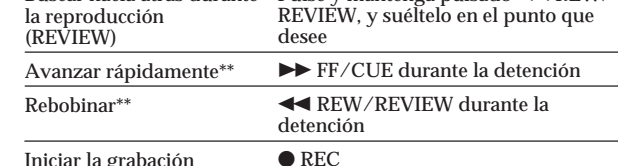
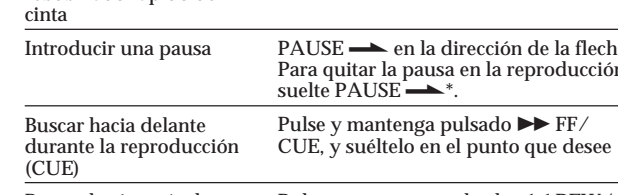
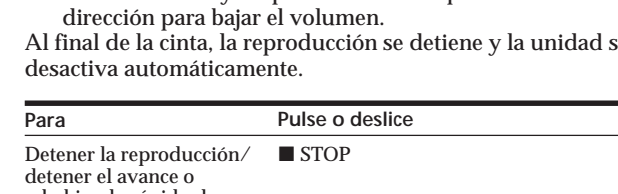
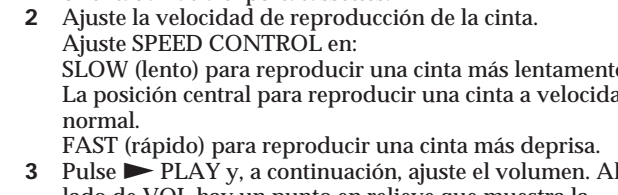
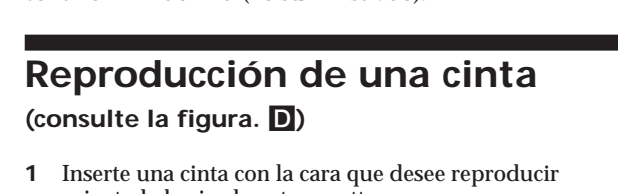
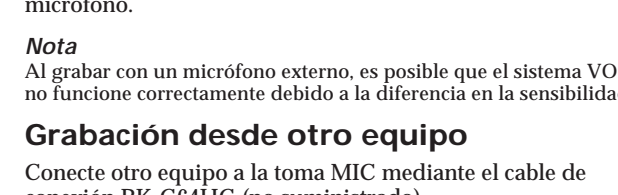
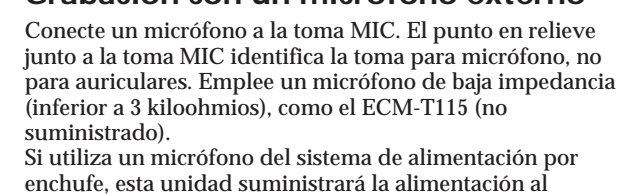
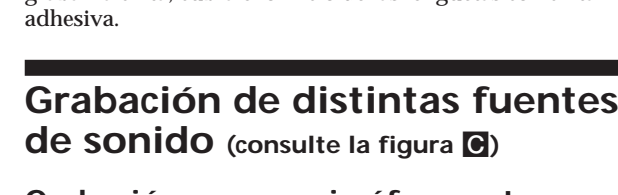
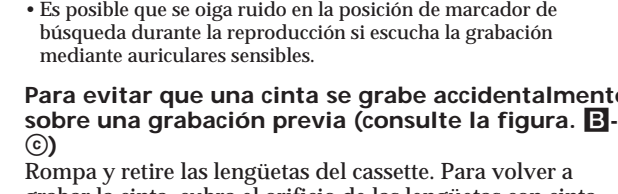
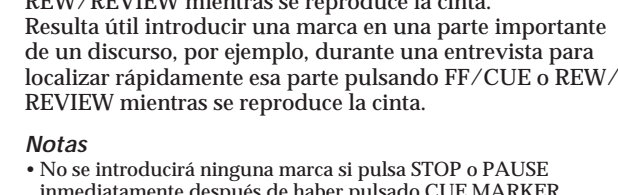
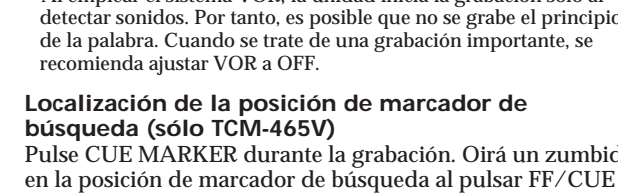
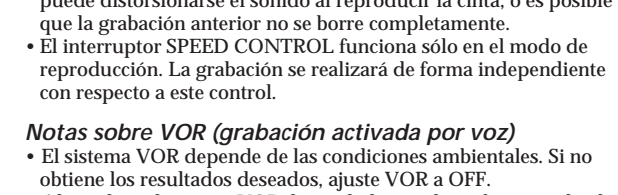
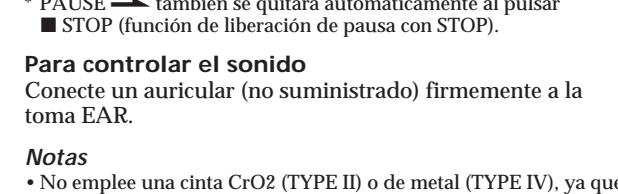
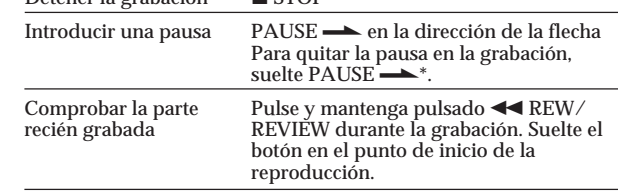
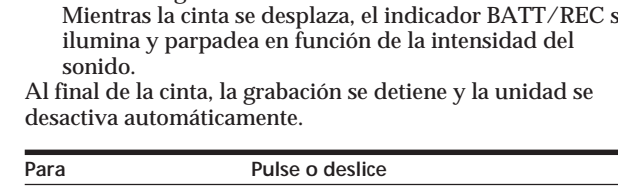
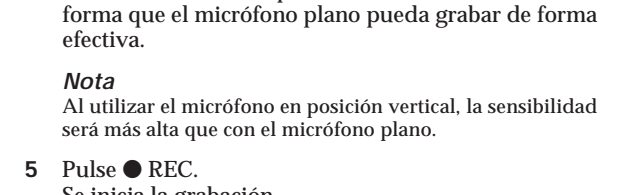
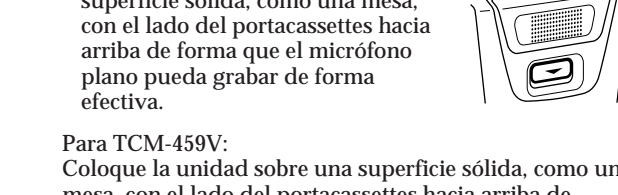
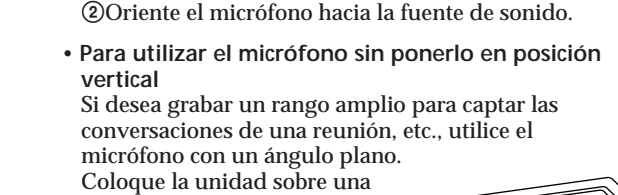
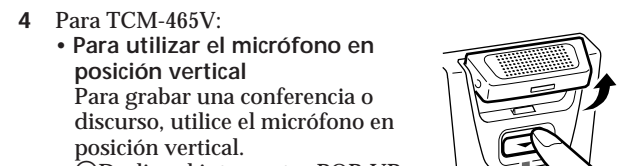
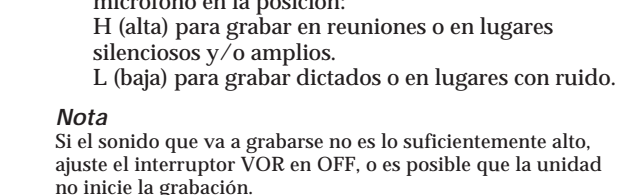
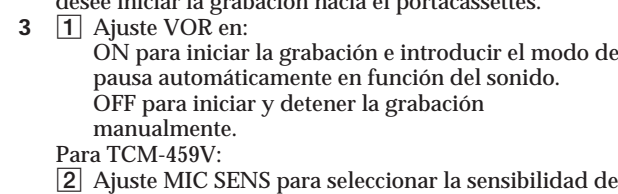
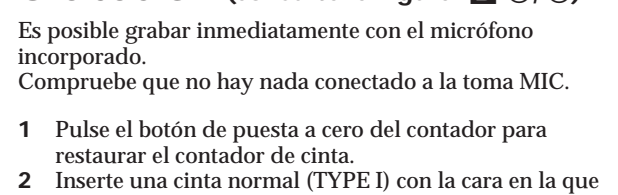
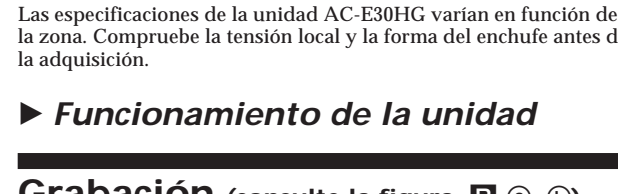
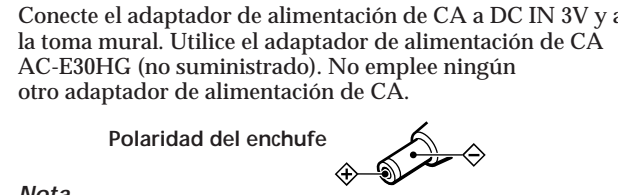
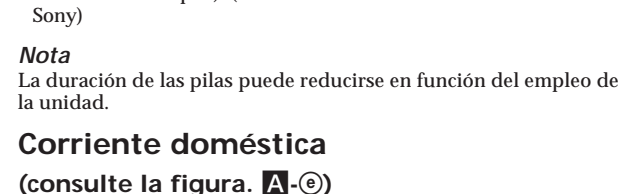
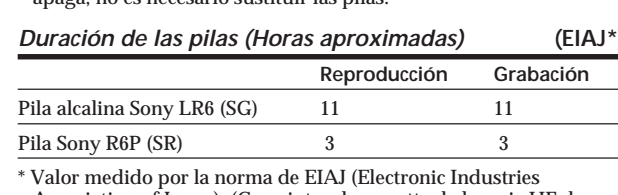
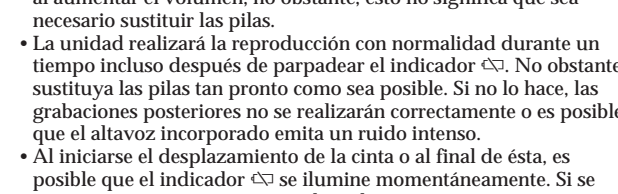
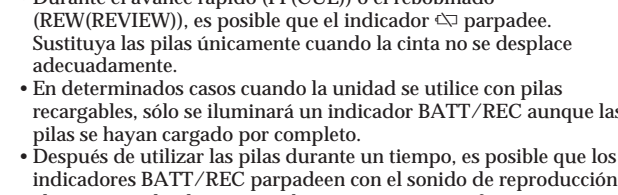
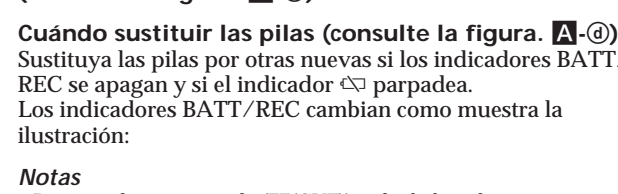
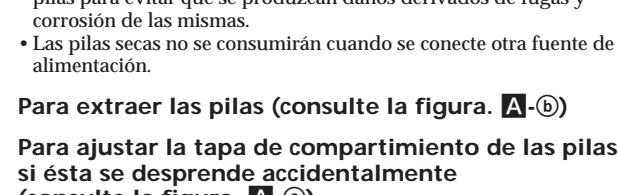
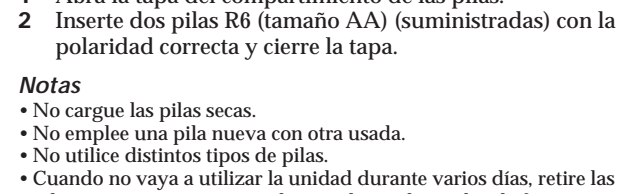
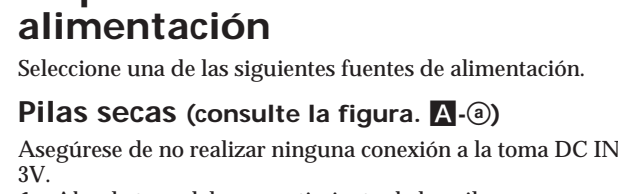
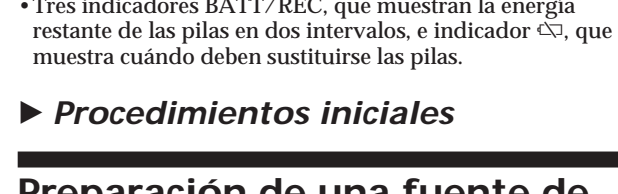
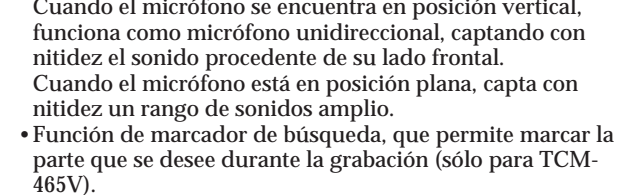
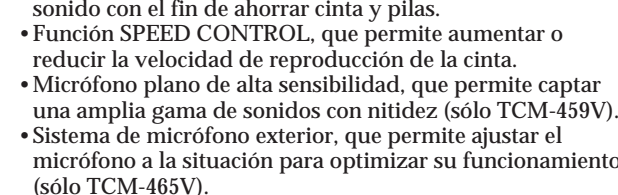
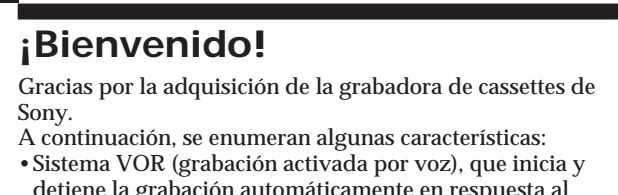
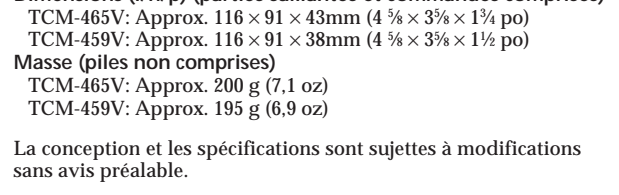
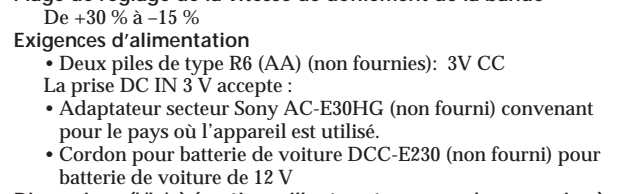
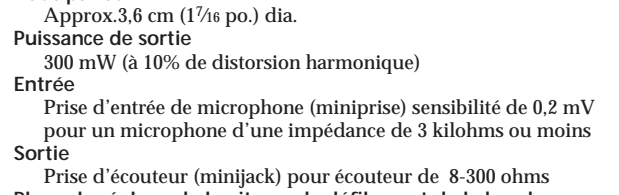
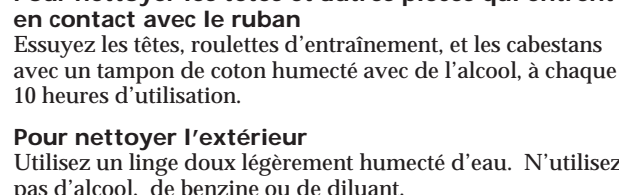
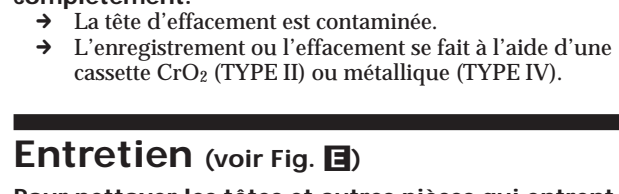
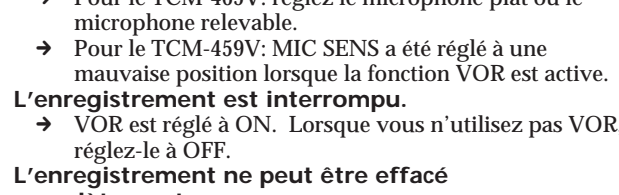
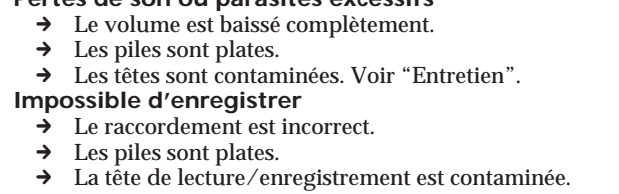
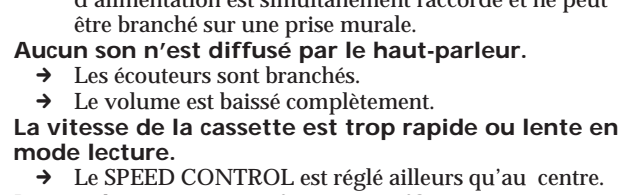
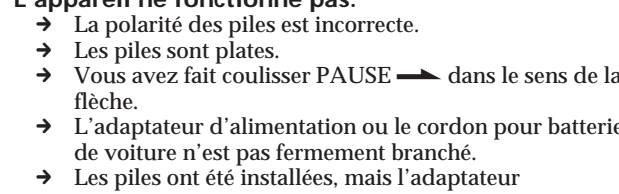
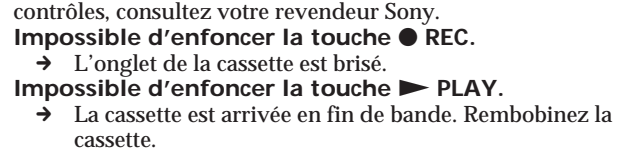
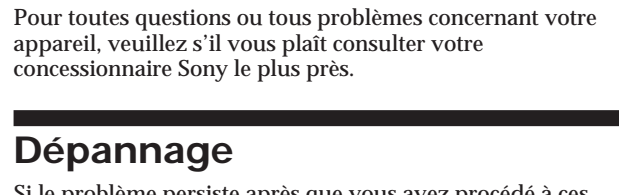
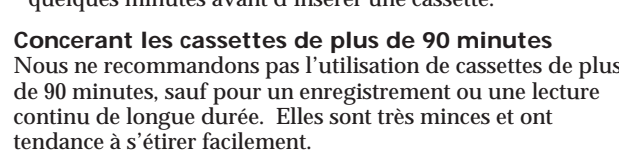
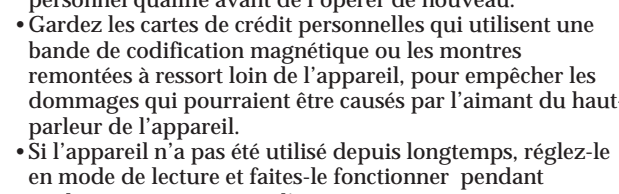
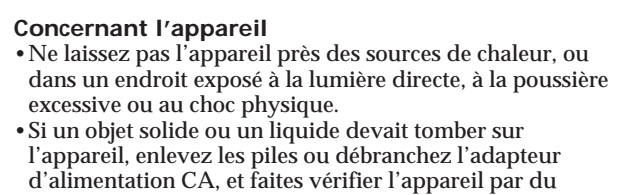
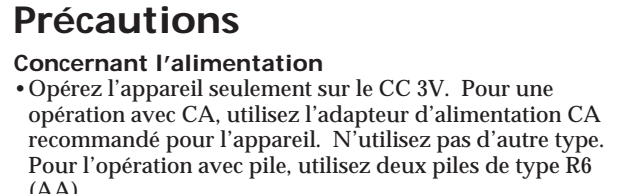
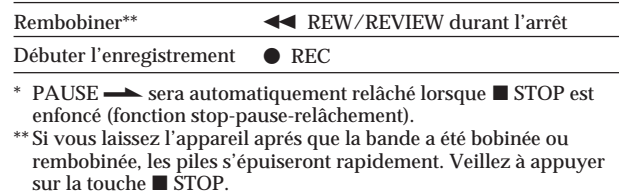
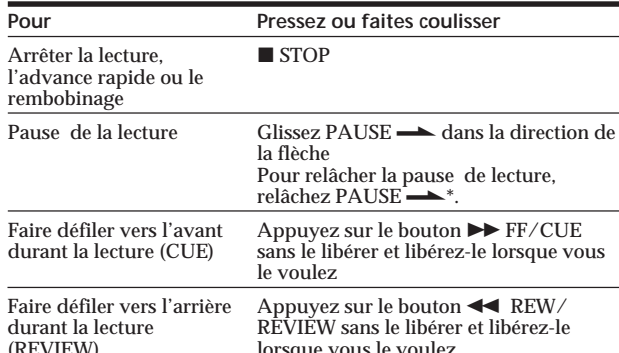
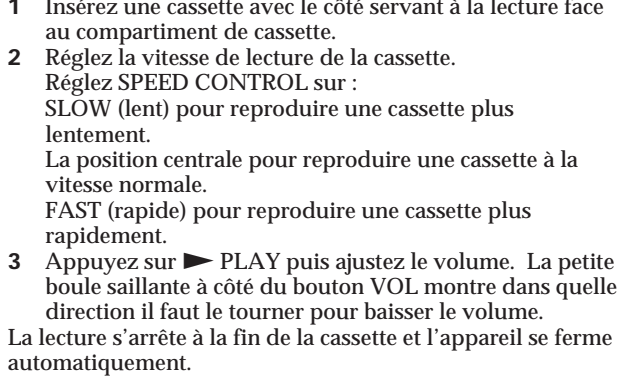
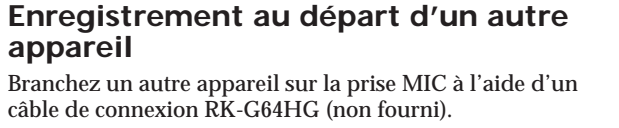
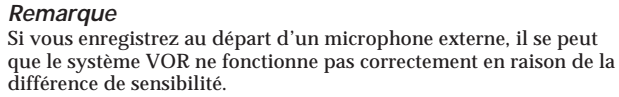
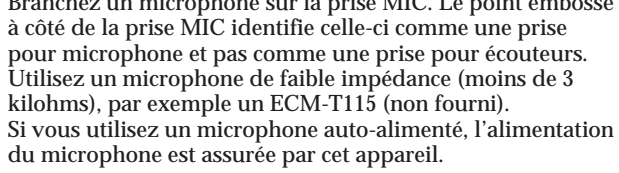
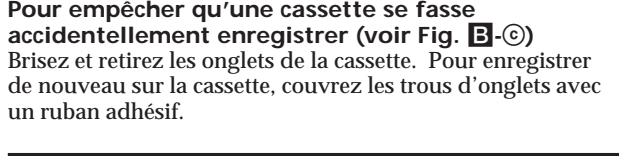
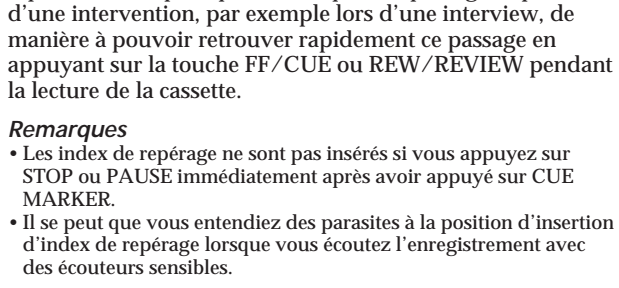
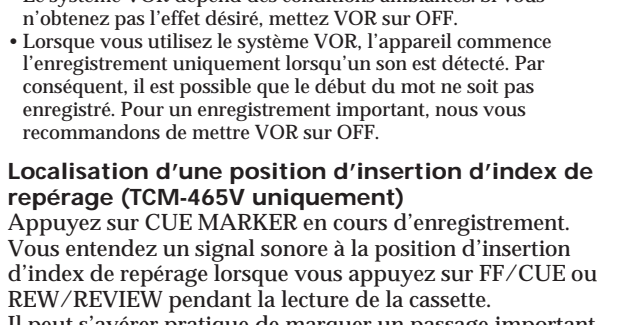
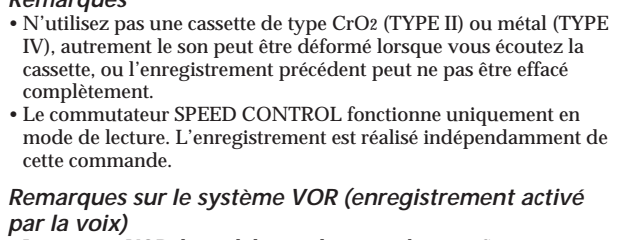
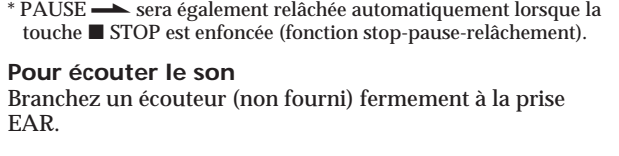
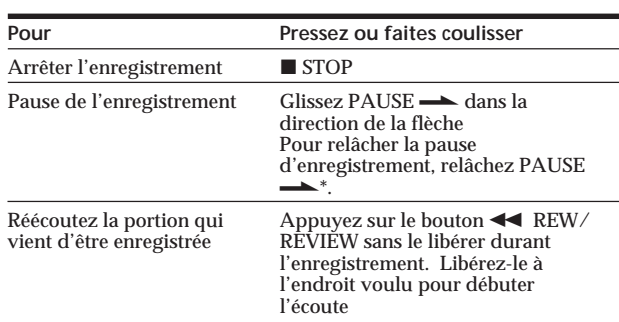
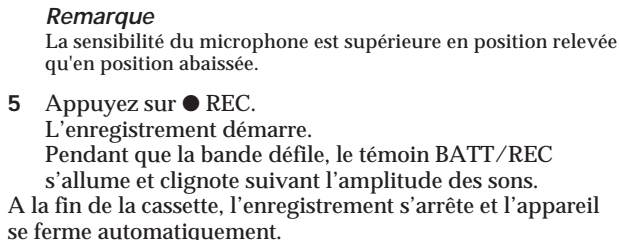
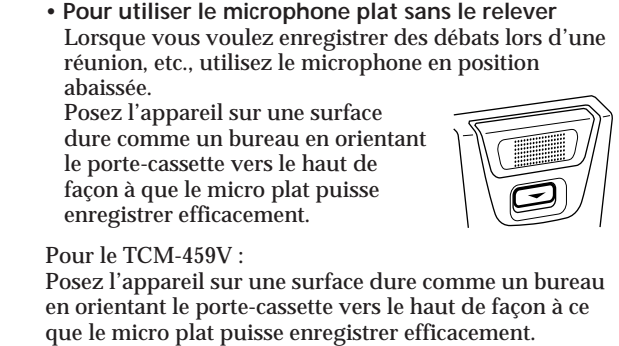
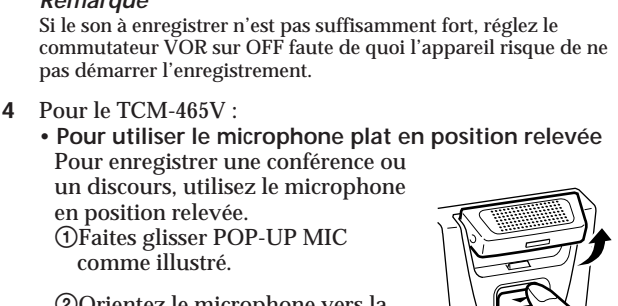
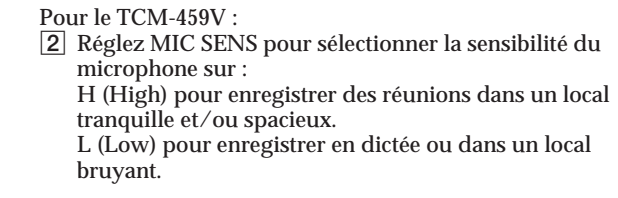
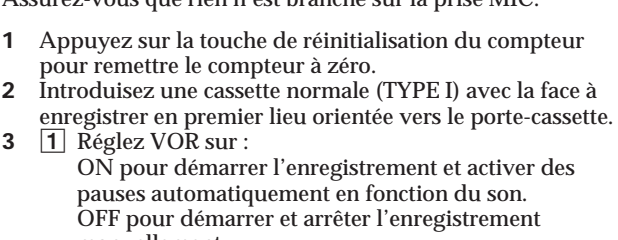
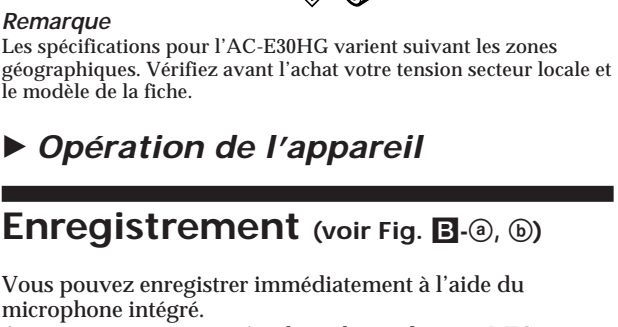
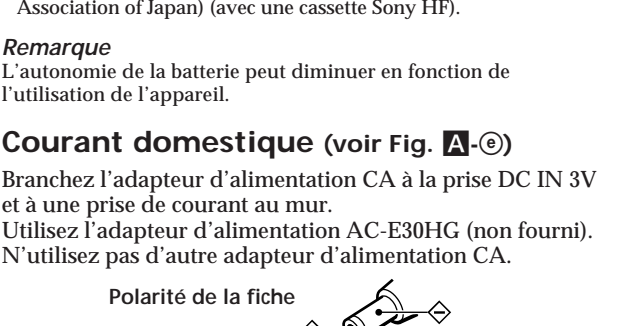
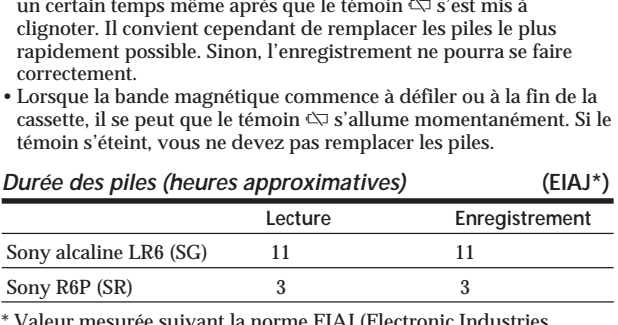
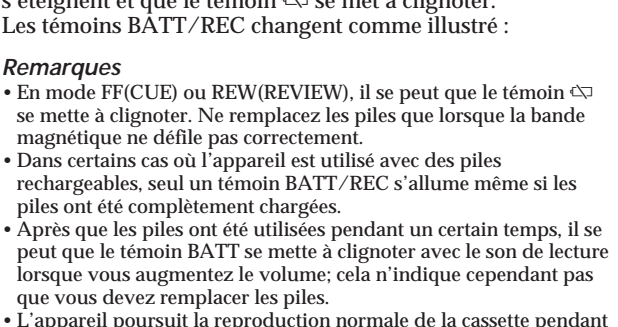
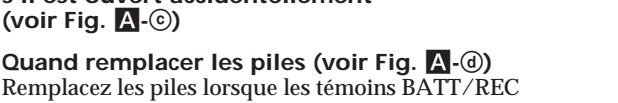
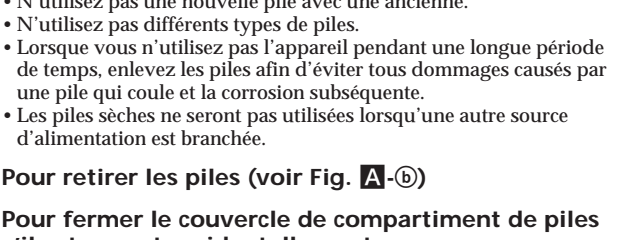
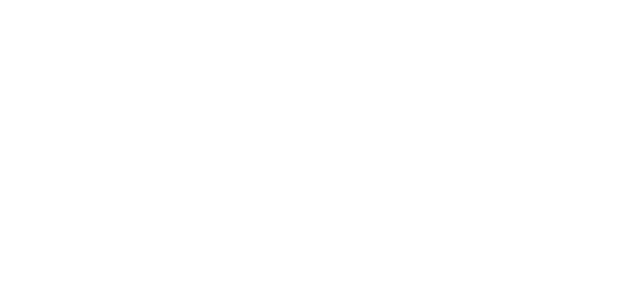
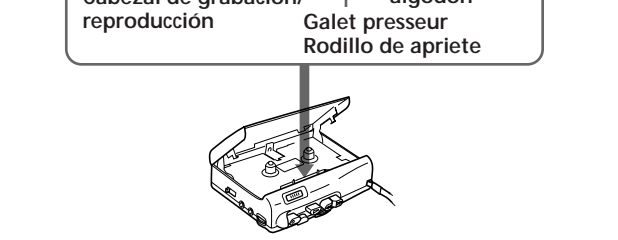
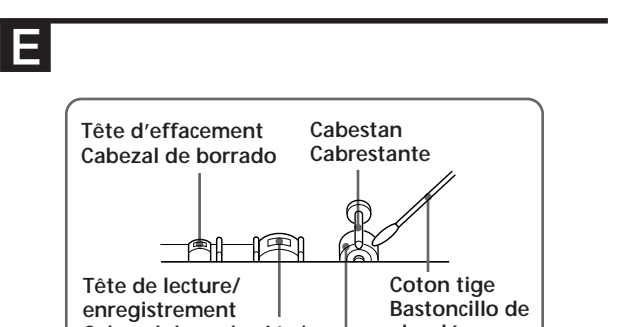
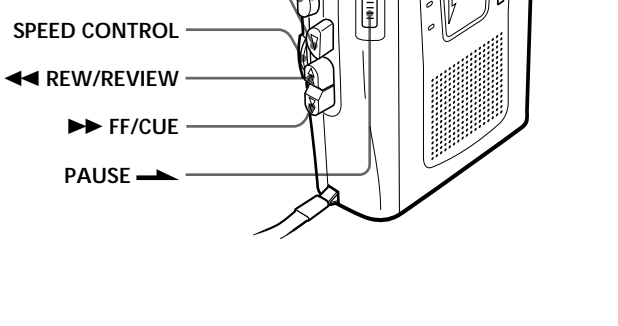
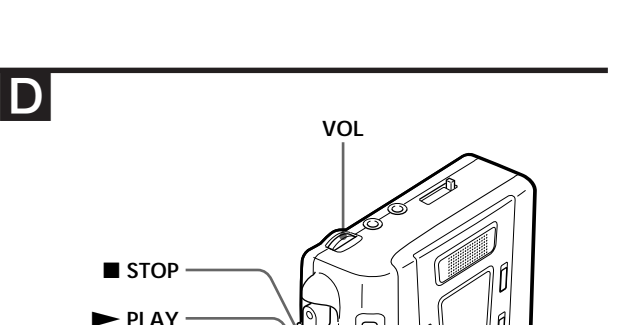
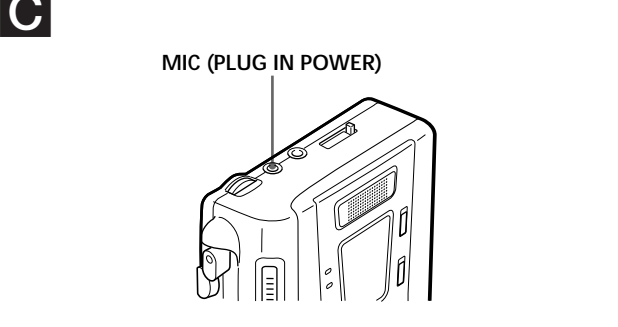
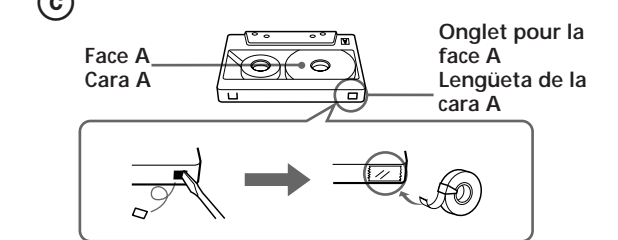
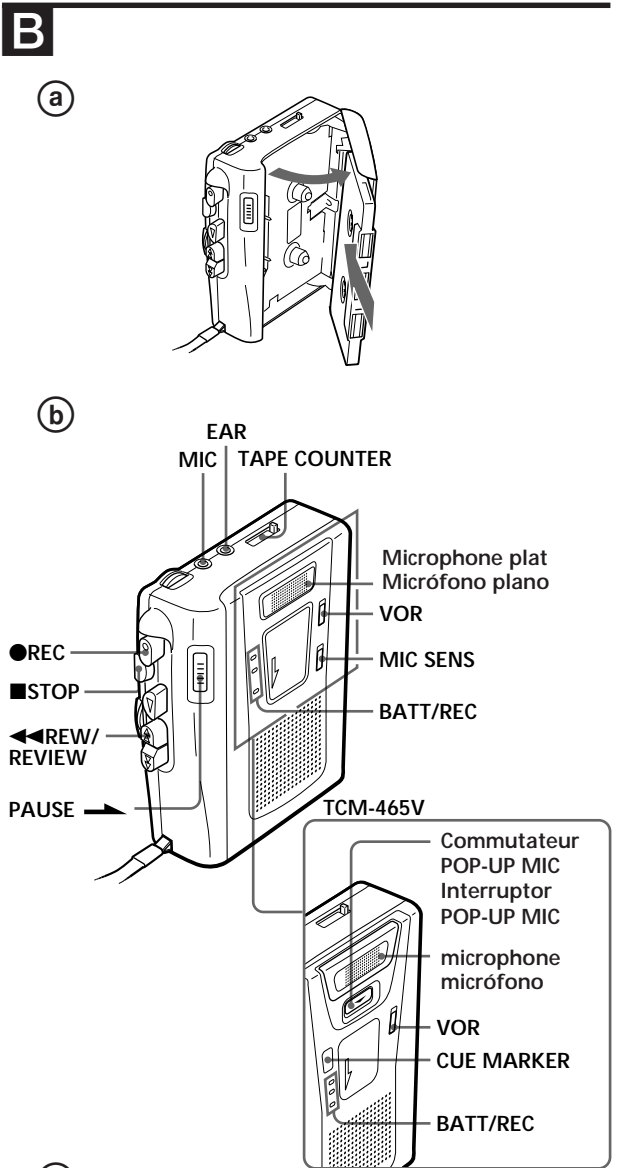
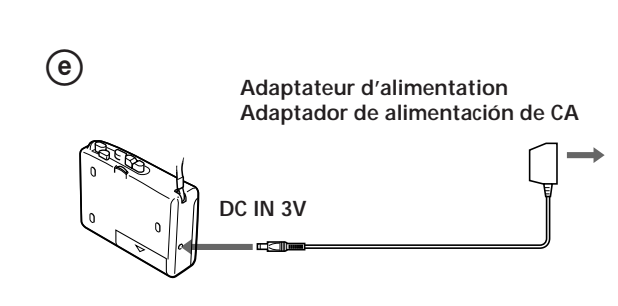
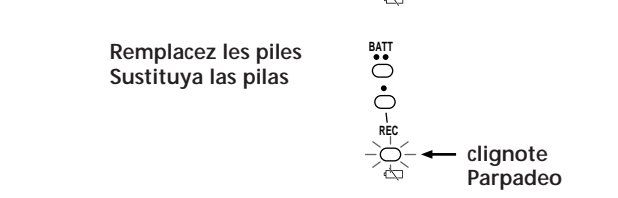
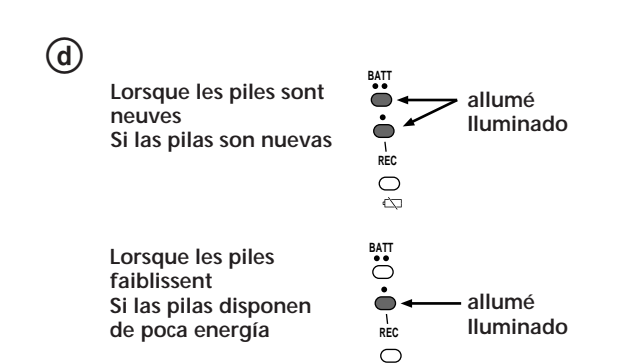
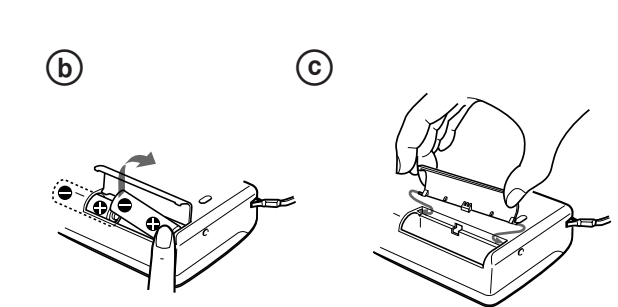
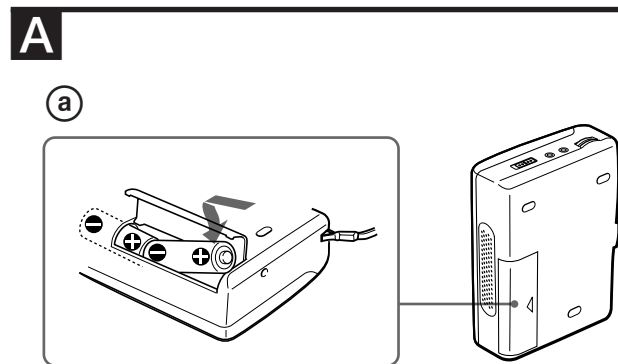

* PAUSE ↔

* PAUSE ↔

* PAUSE ↔

* PAUSE ↔

* PAUSE ↔

* PAUSE ↔

* PAUSE ↔

* PAUSE ↔

* PAUSE ↔

* PAUSE ↔

* PAUSE ↔

* PAUSE ↔

* PAUSE ↔

* PAUSE ↔

* PAUSE ↔

* PAUSE ↔

* PAUSE ↔

* PAUSE ↔

* PAUSE ↔

* PAUSE ↔

* PAUSE ↔

* PAUSE ↔

* PAUSE ↔

* PAUSE ↔

* PAUSE ↔

* PAUSE ↔

